

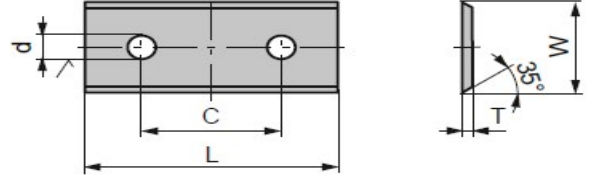



Type	GRASCHE USA Part #	Article	Profile Blank Description	
CTBL RV22..				
 				
CTBL RV22	GP0600350K-80301106	80301106	16098	CTBL RV22 60 x 35 x 2 2 center holes C-44 D-4.1 2 Bevels KCR08
CTBL RV22	GP60402K-11953649	11953649	16145	CTBL RV22 60x40x2 2 center holes C-44 D-4.1 2 bevels KCR08
CTBL ST10..				
 				
CTBL ST10	GP0150205K-11342117	11342117	14554	CTBL ST10 15x20.5x2 H-6.5 D-4.2 no bevel KCR08
CTBL ST10	GP0151203K-80301008	80301008	14556	CTBL ST10 15.1x20.3x2.0 1 bottom hole H-6.0 D-4.2 no bevel KCR08
CTBL ST10	GP0150305K-11342119	11342119	14591	CTBL ST10 15.0x30.5x2.0 1 bottom hole h:6.5 d:4.2 no bevel KCR08
CTBL ST10	GP015030K-11940673	11940673	56084	CTBL ST10 15.0x30.5x2.0 1 bottom hole H-6.5 D-5.1 no bevel KCR08
CTBL ST10	GP0200200K-80301010	80301010	34992	CTBL ST10 20.0x20.5x2.0 1 bottom hole H-6.5 D-4.5 no bevel KCR08
CTBL ST10	GP0200255K-80301011	80301011	34993	CTBL ST10 20.0x25.5x2.0 1 bottom hole H-6.5 D-4.5 no bevel KCR08
CTBL ST10	GP0200305K-80301012	80301012	34994	CTBL ST10 20.0x30.5x2.0 1 bottom hole H-6.5 D-4.5 no bevel KCR08
CTBL ST10	GP0200355K-80301013	80301013	14751	CTBL ST10 20.0x35.5x2.0 1 bottom hole H-6.5 D-4.2 no bevel KCR08
CTBL ST10	GP0250255K-80301015	80301015	14813	CTBL ST10 25.0x25.5x2.0 1 bottom hole H-6.5 D-4.2 no bevel KCR08
CTBL ST10	GP0250305K-11933655	11933655	34997	CTBL ST10 25.0x30.5x2.0 1 bottom hole H-6.5 D-5.8 no bevel KCR08
CTBL ST10	GP0250355K-80301017	80301017	14881	CTBL ST10 25.0x35.5x2.0 1 bottom hole H-6.5 D-4.2 no bevel KCR08
CTBL ST10	GP0300255K-80301019	80301019	38900	CTBL ST10 30.0x25.5x2.0 1 bottom hole H-6.5 D-4.2 no bevel KCR08

Type	GRASCHE USA Part #	Article	Profile Blank Description
CTBL ST10	GP0300305K-11933656	11933656	15066 CTBL ST10 30.0x30.5x2.0 1 bottom hole H-6.5 D-6.0 no bevel KCR08
CTBL ST10	GP0300305K-80301020	80301020	15047 CTBL ST10 30.0x30.5x2.0 1 bottom hole H-6.5 D-4.2 no bevel KCR08
CTBL ST10	GP0300355K-80332963	80332963	15106 CTBL ST10 30.0x35.5x2.0 1 bottom hole H-6.5 D-4.2 no bevel KCR08
CTBL ST10	GP0350250K-80357667	80357667	15287 CTBL ST10 35.0x25.5x2.0 1 bottom hole H-6.5 D-4.2 no bevel KCR08
CTBL ST10	GP0350405K-11933661	11933661	19731 CTBL ST10 35.0x40.5x2.0 1 bottom hole H-6.0 D-6.1 no bevel KCR08

CTBL ST11..

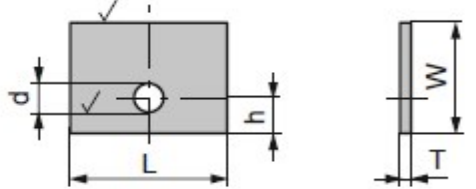
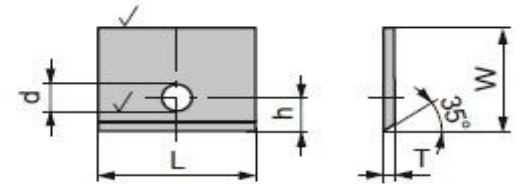

CTBL ST11	GP0200205K-80301048	80301049	14553 CTBL ST11 15.0x20.5x2.0 1 bottom hole H-6.3 D-4.2 bottom bevel KCR08
CTBL ST11	GP0150255K-80301049	80301049	14573 CTBL ST11 15.0x25.5x2.0 1 bottom hole H-6.3 D-4.2 bottom bevel KCR08
CTBL ST11	GP0150305K-80301050	80301050	14590 CTBL ST11 15.0x30.5x2.0 1 bottom hole H-6.3 D-4.2 bottom bevel KCR08
CTBL ST11	GP0200205K-80301051	80301051	14648 CTBL ST11 20.0x20.5x2.0 1 bottom hole H-6.3 D-4.2 bottom bevel KCR08
CTBL ST11	GP0200255K-80301052	80301052	14684 CTBL ST11 20.0x25.5x2.0 1 bottom hole H-6.3 D-4.2 bottom bevel KCR08
CTBL ST11	GP0200305K-80301053	80301053	14723 CTBL ST11 20.0x30.5x2.0 1 bottom hole H-6.3 D-4.2 bottom bevel KCR08
CTBL ST11	GP0200355K-80301054	80301054	14750 CTBL ST11 20x35.5x2.0 1 bottom hole H-6.3 D-4.2 1 bottom bevel KCR08
CTBL ST11	GP0200404K-11965561	11965561	14768 CTBL ST11 20x40.5x2.0 1bottom hole H-6.3 D-4.2 bottom bevel KCR08
CTBL ST11	GP0250255K-80301056	80301056	14812 CTBL ST11 25.0x25.5x2.0 1 bottom hole H-6.3 D-4.2 bottom bevel KCR08
CTBL ST11	GP0250355K-80301058	80301058	14880 CTBL ST11 25.0x35.5x2.0 1 bottom hole H-6.3 D-4.2 bottom bevel KCR08
CTBL ST11	GP0300255K-80301060	80301060	14970 CTBL ST11 30.0x25.5x2.0 1 bottom hole H-6.3 D-4.2 bottom bevel KCR08
CTBL ST11	GP0300305K-80301061	80301061	15045 CTBL ST11 30.0x30.5x2.0 1 bottom hole H-6.3 D-4.2 bottom bevel KCR08
CTBL ST11	GP0300355K-80301062	80301062	15104 CTBL ST11 30.0x35.5x2.0 1 bottom hole H-6.3 D-4.2 bottom bevel KCR08
CTBL ST11	GP025305K-80301057	80301057	14848 CTBL ST11 25x30.5x2 1 bottom hole H-6.3 D-4.2 no bevel KCR08

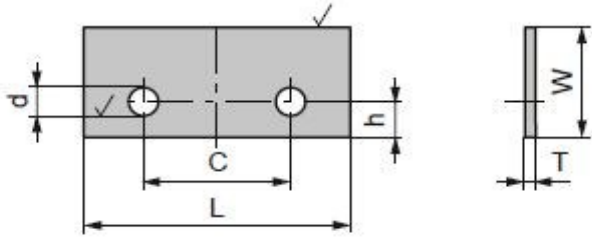

Type	GRASCHE USA Part #	Article	Profile Blank Description	
CTBL ST20..				
 				
CTBL IT20	GP800305K-11965541	11965541	41095	CTBL IT20 80.0x25.5x2.0 2 bottom holes C-60 H-6.5 D-4.5 flat bottom KCR08
CTBL ST20	GP300205K-80301022	80301022	14938	CTBL ST20 30.0x20.5x2.0 2 bottom holes C-14 H-6.5 D-4.2 no bevel KCR08
CTBL ST20	GP0300255K-80301023	80301023	15000	CTBL ST20 30.0x25.5x2.0 2 bottom holes C-14 H-6.5 D-4.2 no bevel KCR08
CTBL ST20	GP0300305K-80301025	80301025	15073	CTBL ST20 30.0x30.5x2.0 2 bottom holes C-14 H-6.5 D-4.2 no bevel KCR08
CTBL ST20	GP0300355K-80301027	80301027	15126	CTBL ST20 30.0x35.5x2.0 2 bottom holes C-14 H-6.5 D-4.2 no bevel KCR08
CTBL ST20	GP0300355K-11933662	11933662	33964	CTBL ST20 30.0x35.5x2.0 2 bottom holes C-12 H-6.0 D-6.0 no bevel KCR08
CTBL NS20	GP0300355M-11486307	11486307	33964	CTBL NS20 30.0x35.5x2.0 2 bottom holes C-12 H-6.0 D-6.0 no bevel MG18
CTBL ST20	GP0350305K-80301029	80301029	15351	CTBL ST20 35.0x30.5x2.0 2 bottom holes C-14 H-6.5 D-4.2 no bevel KCR08
CTBL ST20	GP0350355K-80301030	80301030	15383	CTBL ST20 35.0x35.5x2.0 2 bottom holes C-14 H-6.5 D-4.2 no bevel KCR08
CTBL ST20	GP0350405K-11755257	11755257	15411	CTBL ST20 35.0x40.5x2.0 2 bottom holes C-14 H-6.5 D-4.2 no bevel KCR08
CTBL ST20	GP0400205K-80301031	80301031	15441	CTBL ST20 40.0x20.5x2.0 2 bottom holes C-26 H-6.5 D-4.2 no bevel KCR08
CTBL ST20	GP0400200K-11933721	11933721		CTBL ST20 40.0x20.0x2.0 2 bottom holes C-26 H-5.5 D-6.0 no bevel KCR08
CTBL ST20	GP0400205K-11933666	11933666	37885	CTBL ST20 40.0x20.5x2.0 2 bottom holes C-26 H-5.5 D-5.5 no bevel KCR08
CTBL ST20	GP0400255K-80301032	80301032	15484	CTBL ST20 40.0x25.5x2.0 2 bottom holes C-26 H-6.5 D-4.2 no bevel KCR08
CTBL ST20	GP0400305K-80301033	80301033	15544	CTBL ST20 40.0x30.5x2.0 2 bottom holes C-26 H-6.5 D-4.2 no bevel KCR08
CTBL ST20	GP0400305K-11933668	11933668		CTBL ST20 40.0x30.5x2.0 2 bottom holes C-26 H-5.5 D-5.0 no bevel KCR08
CTBL ST20	GP0400305K-11933669	11933669	19253	CTBL ST20 40.0x30.5x2.0 2 bottom holes C-26 H-5.5 D-6.0 no bevel KCR08
CBTL ST20	GP0400305M-11849138	11849138	19471	CBTL ST20 40.0x30.5x2.0 2 bottom holes C-26 H-5.5 D-6.0 no bevel MG18
CTBL ST20	GP0400355K-11933672	11933672	18955	CTBL ST20 40.0x35.5x2.0 2 bottom holes C-27 H-6.3 D-5.0 no bevel KCR08
CTBL ST20	GP0400355K-11933676	11933676	19471	CTBL ST20 40.0x35.5x2.0 2 bottom holes C-26 H-5.5 D-6.0 no bevel KCR08
CTBL ST20	GP0400355K-80301034	80301034	15612	CTBL ST20 40.0x35.5x2.0 2 bottom holes C-26 H-6.5 D-4.2 no bevel KCR08
CTBL ST20	GP0400405K-80301035	80301035	15647	CTBL ST20 40.0x40.5x2.0 2 bottom holes C-26 H-6.5 D-4.2 no bevel KCR08
CTBL ST20	GP0400405K-11933677	11933677	19002	CTBL ST20 40.0x40.5x2.0 2 bottom holes C-27 H-6.3 D-5.0 no bevel KCR08
CTBL ST20	GP0400405K-11933678	11933678	19254	CTBL ST20 40.0x40.5x2.0 2 bottom holes C-26 H-5.5 D-6.0 no bevel KCR08
CTBL ST20	GP0500205K-80301036	80301036	15805	CTBL ST20 50.0x20.5x2.0 2 bottom holes C-26 H-6.5 D-4.2 no bevel KCR08
CTBL ST20	GP0500255K-80301037	80301037	15843	CTBL ST20 50.0x25.5x2.0 2 bottom holes C-26 H-6.5 D-4.2 no bevel KCR08

Type	GRASCHE USA Part #	Article		Profile Blank Description
CTBL ST20	GP0500255K-11933682	11933682	19065	CTBL ST20 50.0x25.5x2.0 2 bottom holes C-26 H-6.5 D-5.0 no bevel KCR08
CTBL ST20	GP0500305K-80301038	80301038	15872	CTBL ST20 50.0x30.5x2.0 2 bottom holes C-26 H-6.5 D-4.2 no bevel KCR08
CTBL ST20	GP0500305K-11933684	11933684	19382	CTBL ST20 50.0x30.5x2.0 2 bottom holes C-26 H-6.5 D-6.0 no bevel KCR08
CTBL ST20	GP0500355K-80301040	80301040	15897	CTBL ST20 50.0x35.5x2.0 2 bottom holes C-26 H-6.5 D-4.2 no bevel KCR08
CTBL ST20	GP0500405K-11933685	11933685	19383	CTBL ST20 50.0x40.5x2.0 2 bottom holes C-26 H-6.5 D-6.0 no bevel KCR08
CTBL ST20	GP0600305K-11353637	11353637	16069	CTBL ST20 60.0x30.5x2.0 1 bottom hole C-26 H-6.5 D-4.2 no bevel KCR08
CTBL ST20	GP0600355K-80301042	80301042	16116	CTBL ST20 60.0x35.5x2.0 2 bottom holes C-26 H-6.5 D-4.2 no bevel KCR08
CTBL ST20	GP0600405K-80301043	80301043	16160	CTBL ST20 60.0x40.5x2.0 2 bottom holes C-26 H-6.5 D-4.2 no bevel KCR08
CTBL ST20	GP0800405K-80357685	80357685		CTBL ST20 80.0 x 40.5 x 2.0 2 bottom holes C-60 H-6.5 D-4.2 no bevel KCR08

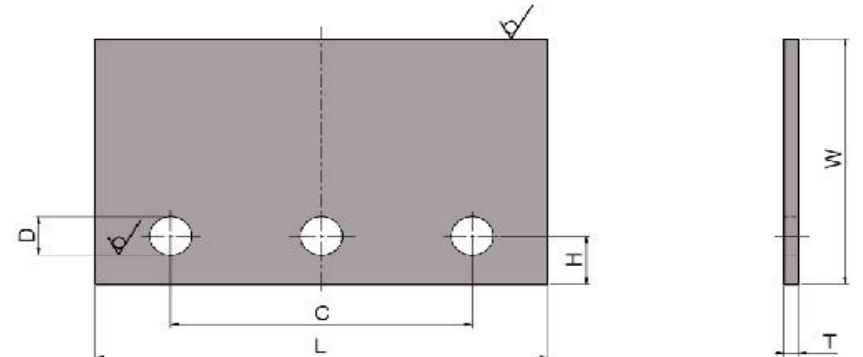
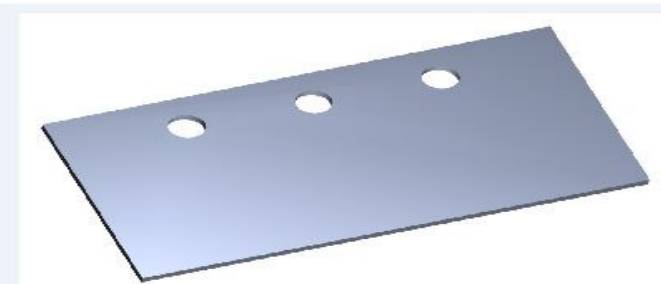
CTBL ST30..

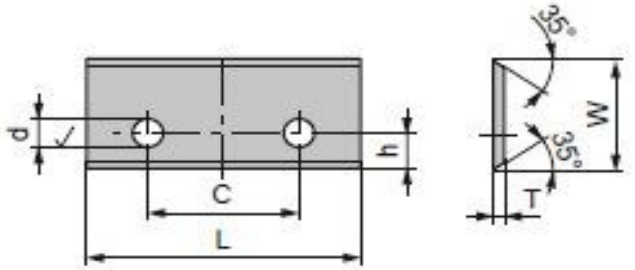

CTBL ST30	GP0600305K-11239112	11239112	19162	CTBL ST30 60.0x30.5x2.0 3 bottom holes C-20 H-7.0 D-5.6 no bevel KCR08
CTBL ST30	GP0600355K-11933738	11933738	19472	CTBL ST30 60.0x35.5x2.0 3 bottom holes C-20 H-7.0 D-5.6 no bevel KCR08
CTBL ST30	GP0600405K-11933739	11933739	19163	CTBL ST30 60.0x40.5x2.0 3 bottom holes C-20 H-7.0 D-5.6 no bevel KCR08
CTBL ST30	GP0800305K-11239113	11239113	19164	CTBL ST30 80.0x30.5x2.0 3 bottom holes C-20 H-7.0 D-5.6 no bevel KCR08
CTBL ST30	GP0800355K-11933741	11933741	19473	CTBL ST30 80.0x35.5x2.0 3 bottom holes C-20 H-7.0 D-5.6 no bevel KCR08
CTBL ST30	GP0800405K-11933743	11933743	19165	CTBL ST30 80.0x40.5x2.0 3 bottom holes C-20 H-7.0 D-5.6 no bevel KCR08

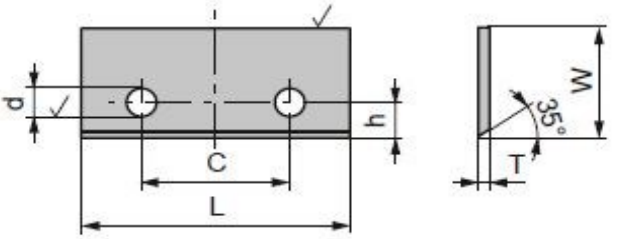

Type	GRASCHE USA Part #	Article	Profile Blank Description	
CTBL ST22..				
 				
CTBL ST22	GP0400350K-11933723	11933723	15630	CTBL ST22 40.0x35.0x2.0 2 bottom holes C-20 H-5.5 D-4.1 two bevels KCR08
CTBL ST22	GP0400400K-11933724	11933724	15655	CTBL ST22 40.0x40.0x2.0 2 bottom holes C-20 H-6.0 D-4.1 two bevels KCR08
CTBL ST22	GP0500250H-80357745	80357745	15641	CTBL ST22 50.0x25.0x2.0 2 bottom holes C-26 H-5.5 D-4.2 2 bevels HC05
CTBL ST22	GP60035K-11953650	11953650	16126	CTBL ST22 60x35.5x2 2 bottom holes C-44 H-6.0 D-4.1 2 bevels KCR08
CTBL ST22	GP60405K-11953653	11953653	16158	CTBL ST22 60x40.5x2 2 bottom holes C-44 H-6.0 D-4.1 2 bevels KCR08
CTBL ST22	GP60045k-11953656	11953656	19375	CTBL ST22 60x45.5x2 2 bottom holes C-44 H-6.0 D-4.1 2 bevels KCR08
CTBL ST21..				
 				
CTBL ST21	GP0300205K-80301069	80301069	39328	CTBL ST21 30.0x20.5x2.0 2 bottom holes C-14 H-6.3 D-4.2 bottom bevel KCR08
CTBL ST21	GP0300255K-80301070	80301070	15007	CTBL ST21 30.0x25.5x2.0 2 bottom holes C-14 H-6.3 D-4.2 bottom bevel KCR08
CTBL ST21	GP0300255K-11987241	11987241	14999	CTBL ST21 30.0x25.5x2.0 2 bottom holes C-14 H-5.5 D-4.1 Bottom Bevel KCR08
CTBL ST21	GP0300305K-11848567	11828567	15072	CTBL ST21 30.0x30.5x2.0 2 bottom holes C-14 H-5.5 D-4.1 Bottom Bevel KCR08
CTBL ST21	GP0300305K-80301071	80301071	39329	CTBL ST21 30.0x30.5x2.0 2 bottom holes C-14 H-6.3 D-4.2 bottom bevel KCR08
CTBL ST21	GP0300305K-11848567	11848567	15072	CTBL ST21 30.0x30.5x2.0 2 bottom holes C-14 H-5.5 D-4.1 Bottom Bevel KCR08
CTBL ST21	GP0300355K-80301072	80301072	19495	CTBL ST21 30.0x35.5x2.0 2 bottom holes C-14 H-6.3 D-4.2 bottom bevel KCR08
CTBL ST21	GP0400255K-80301077	80301077	39330	CTBL ST21 40.0x25.5x2.0 2 bottom holes C-26 H-6.3 D-4.2 bottom bevel KCR08

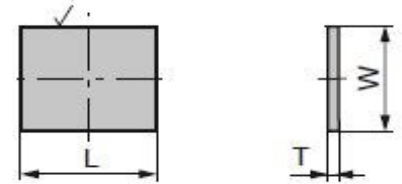

Type	GRASCHE USA Part #	Article		Profile Blank Description
CTBL ST21	GP0400305K-80301078	80301078	15571	CTBL ST21 40.0x30.5x2.0 2 bottom holes C-26 H-6.3 D-4.2 bottom bevel KCR08
CTBL ST21	GP0400355K-80301079	80301079	39331	CTBL ST21 40.0x35.5x2.0 2 bottom holes C-26 H-6.3 D-4.2 bottom bevel KCR08
CTBL ST21	GP0400405K-80301080	80301080	39567	CTBL ST21 40.0x40.5x2.0 2 bottom holes C-26 H-6.3 D-4.2 bottom bevel KCR08
CTBL ST21	GP0500255K-80301082	80301082	39568	CTBL ST21 50.0x25.5x2.0 2 bottom holes C-26 H-6.3 D-4.2 bottom bevel KCR08
CTBL ST21	GP0500305K-80301083	80301083	39569	CTBL ST21 50.0x30.5x2.0 2 bottom holes C-26 H-6.3 D-4.2 bottom bevel KCR08
CTBL ST21	GP0500355K-80301084	80301084	18387	CTBL ST21 50.0x35.5x2.0 2 bottom holes C-26 H-6.3 D-4.2 bottom bevel KCR08
CTBL ST21	GP0600355K-80301088	80301088	39572	CTBL ST21 60.0x35.5x2.0 2 bottom holes C-26 H-6.3 D-4.2 bottom bevel KCR08
CTBL ST21	GP600355K-11933745	11933745	16126	CTBL ST21 60.0x35.5x2.0 2 bottom holes C-44 H-6.3 D-4.2 bottom bevel KCR08
CTBL ST21	GP0600405K-80301090	80301090	39573	CTBL ST21 60.0x40.5x2.0 2 bottom holes C-26 H-6.3 D-4.2 bottom bevel KCR08
CTBL ST21	GP0600405K-11933744	11933744	16158	CTBL ST21 60.0x40.5x2.0 2 bottom holes C-44 H-6.3 D-4.2 bottom bevel KCR08

CTBL WH00..

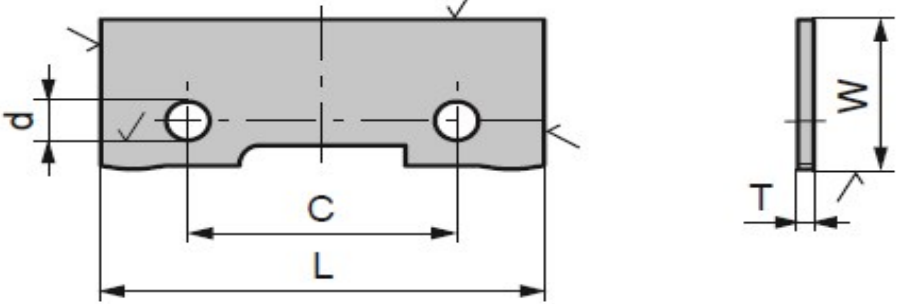

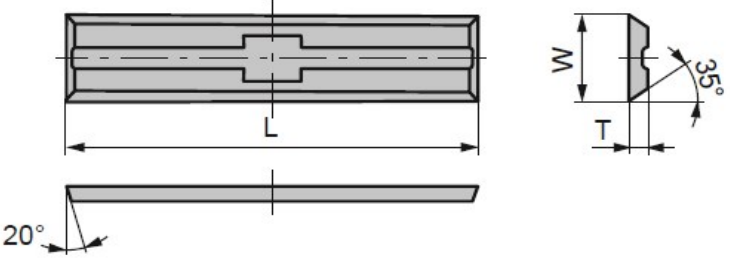
CTBL WH00	GP0250305M-82021577	82021577	107723	CTBL WH00 25.0x30.5x2.0 no holes no bevel MG18
CTBL WH00	GP0300205M-82010615	82010615	107725	CTBL WH00 30.0x20.5x2.0 no holes no bevel MG18
CTBL WH00	GP0300255M-82013140	82013140	107726	CTBL WH00 30.0x25.5x2.0 no holes no bevel MG18
CTBL WH00	GP0300305M-82013141	82013141	107727	CTBL WH00 30.0x30.5x2.0 no holes no bevel MG18
CTBL WH00	GP0300355M-82014358	82014358	107728	CTBL WH00 30.0x35.5x2.0 no holes no bevel MG18
CTBL WH00	GP0350205M-82020661	82020661	107730	CTBL WH00 35.0x20.5x2.0 no holes no bevel MG18
CTBL WH00	GP0350255M-82019562	82019562	107731	CTBL WH00 35.0x25.5x2.0 no holes no bevel MG18
CTBL WH00	GP0350305M-82019577	82019577	107732	CTBL WH00 35.0x30.5x2.0 no holes no bevel MG18
CTBL WH00	GP0350355M-82019397	82019397	107733	CTBL WH00 35.0x35.5x2.0 no holes no bevel MG18
CTBL WH00	GP0400255M-82021325	82021325	107736	CTBL WH00 40.0x25.5x2.0 no holes no bevel MG18
CTBL WH00	GP0400305M-82010250	82010250	107737	CTBL WH00 40.0x30.5x2.0 no holes no bevel MG18
CTBL WH00	GP0500305M-82013697	82013697	107744	CTBL WH00 50.0x30.5x2.0 no holes no bevel MG18
CTBL WH00	GP0500355M-82022404	82022404	107745	CTBL WH00 50.0x35.5x2.0 no holes no bevel MG18

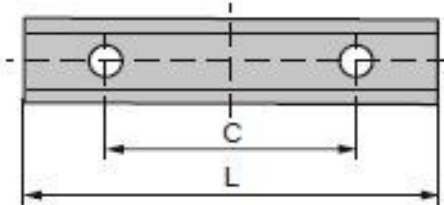
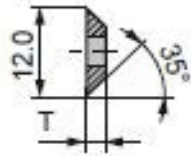
Type	GRASCHE USA Part #	Article	Profile Blank Description	
SUPERPROFILER				
 				
CTBL SP20	GP410280K-80301115	80301115	15701	CTBL SP20 40.6 x 28.2 x 1.5 Super Profiler KCR08
CTBL SP20	GP410280K-80301116	80301116	15695	CTBL SP20 40.6 x 28.2 x 2.0 Super Profiler KCR08
CTBL SP20	GP610450K-80301118	80301118	16234	CTBL SP20 60.6 x 45.6 x 2.0 Super Profiler KCR08
CTBL SP20	GP610310K-80301117	80301117	16209	CTBL SP20 60.8 x 30.2 x 1.5 Super Profiler KCR08
CTK MK..BCG				
 				
	GK0800405K-80357685	80357685		CTBL ST20 80.0 x 40.5 x 2.0 2 bottom holes C-60 H-6.5 D-4.2 no bevel KCR08

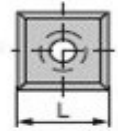
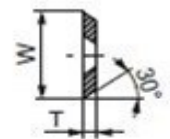
Type	GRASCHE USA Part #	Article	Profile Blank Description	
CTK ST				
  				
CTK ST	GK30012K-80358833	80358833	12005	CTK ST 30.0x12.0x1.5 c-14 a-35 2-cutting edges KCR08
CTK ST	GK30012S-80330674	80330674	37750	CTK ST 30.0x12.0x1.5c-13 a-35 2-cutting edges SMG02
EL CTK ST	GK300120C-11742547	11742547	13982	EL CTK ST 30.0x12.0x1.5 c-14 a-35 2-cutting edges CTOPP10
CTK ST	GK30012K-12054645	12054645	54259	CTK ST 30.0x12.0x2.5 c-14 2-cutting edges KCR08
CTK ST	GK40012K-80360025	80360025	12014	CTK ST 40.0x12.0x1.5 c-26 a-35 2-cutting edges KCR08
EL CTK ST	GK400120C-11791003	11791003	14006	EL CTK ST 40.0x12.0x1.5 c-26 a-35 2-cutting edges CTOPP10
CTK ST	GK40012S-80358316	80358316	52278	CTK ST 40.0x12.0x1.5 c-26 a-35 2-cutting edges SMG02
CTK ST	GK50012K-80358835	80358835	12006	CTK ST 50.0x12.0x1.5 c-26 a-35 2-cutting edges KCR08
EL CTK ST	GK500120C-11742544	11742544	13987	EL CTK ST 50.0x12.0x1.5 c-26 a-35 2-cutting edges CTOPP10
CTK ST	GK50012S-80330675	80330675	37901	CTK ST 50.0x12.0x1.5 c-26 a-35 2-cutting edges SMG02
CTK ST	GK60012K-80360026	80360026	12007	CTK ST 60.0x12.0x1.5 c-26 a-35 2-cutting edges KCR08
EL CTK ST	GK600120C-11791004	11791004	13994	EL CTK ST 60.0x12.0x1.5 c-26 a-35 2-cutting edges CTOPP10
CTK ST	GK60012S-80358317	80358317	54882	CTK ST 60.0x12.0x1.5 c-26 a-35 2-cutting edges SMG02
CTK SC..				
  				
CTK SC	GK140140K-80359802	80359802	13260	CTK SC 14.0x14.0x2.0 a-30 4-cutting edges KCR08
CTK SC	GK140140S-80332539	80332539	54962	CTK SC 14.0x14.0x2.0 a-30 4-cutting edges SMG02

Type	GRASCHE USA Part #	Article		Profile Blank Description
EL CTK SC	GK140140C-11742545	11742545	14028	EL CTK SC 14.0x14.0x2.0 a-30 4-cutting edges CTOPP10
CTK SC	GK14014H-80330669	80330669		CTK SC 14.0x14.0x1.2 a-30 4-cutting edges HC05
CTK SC	GK146146K-11444230	11444230	13314	CTK SC 14.6x14.6x2.5 a-35 4-cutting edges KCR08
CTK SC	GK15015M-82001124	82001124	13315	CTK SC 15.0x15.0x2.5 a-30 4-cutting edges MG18

EL CTK SC..R r0.5

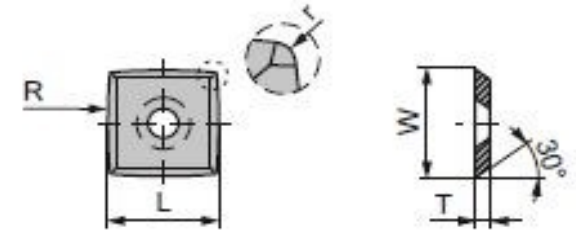





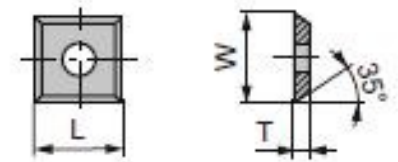

CTK SC	GK140140K-12112468	12112468	104117	CTK SC 14.0x14.0x2.0 4 straight cutting edges with R05 Radiused corners KCR08
EL CTK SC	GK150150K-12112633	12112633	101540	CTK SC 15.0x15.0x2.5 4-radiused cutting edges R150 4-corner breaks R05 KCR08
EL CTK SC	GK150150C-11827617	11827617	115179	EL CTK SC 15.0x15.0x2.5 4-radiused cutting edges R115 4-corner bev R05 CTOPP10
EL CTK SC	GK150150C-11827613	11827613	101540	EL CTK SC 15.0x15.0x2.5 4-radiused cutting edges R150 4-corner bev R05 CTOPP10
EL CTK SC	GK150150C-11789902	11789902		EL CTK SC 15.0x15.0x2.5 4-radiused cutting edges R115 square corner CTOPP10
EL CTK SC	GK150150C-11789899	11789899	104115	EL CTK SC 15.0x15.0x2.5 4-radiused cutting edges R150 square corner CTOPP10
CTK SC	GK15015K-82022498	82022498	104118	CTK SC 15.0x15.0x2.5 4-cutting edges R05 orner breaks only KCR08
CTK SC	GK15015M-82023168	82023168		CTK SC 15.0x15.0x2.5 4-radiused cutting edges R115 4-corner breaks R05 MG18

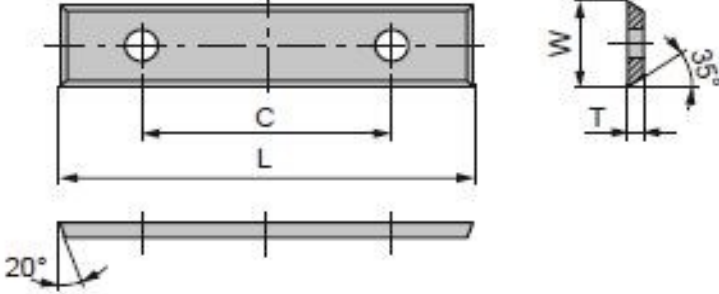

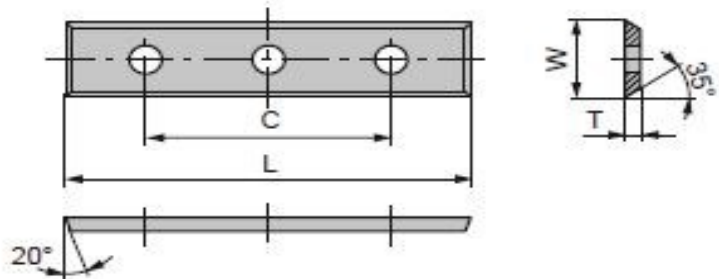
CTK FC..



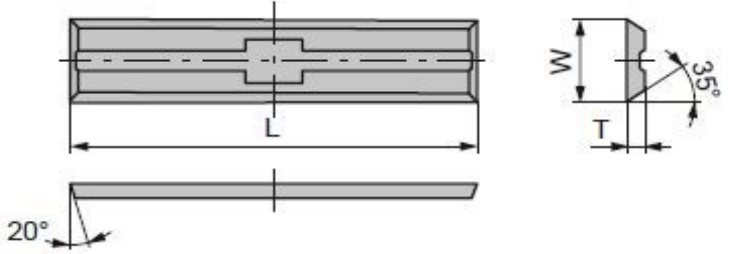



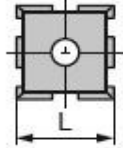
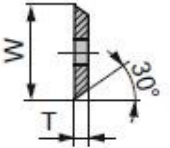

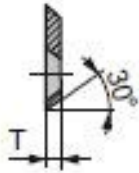
CTK FC	GK12012K-80360030	80360030	12002	CTK FC 12.0x12.0x1.5 a-35 4-cutting edges KCR08
--------	-------------------	----------	-------	---

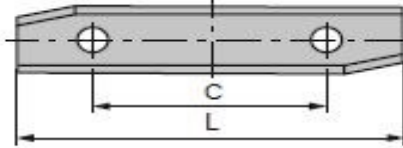
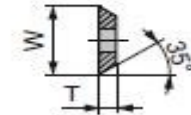

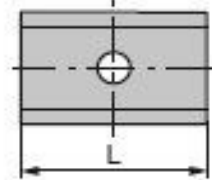
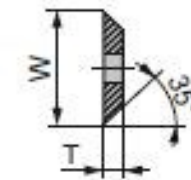
Type	GRASCHE USA Part #	Article		Profile Blank Description
CTK FC	GK12012S-80358314	80358314	48357	CTK FC 12.0x12.0x1.5 a-35 4-cutting edges SMG02
CTK FC..				
 				
CTK FC	GK29512K-80360081	80360081	13504	CTK FC 29.5x 9.0x1.5 C-14 a-35 B-20 4-cutting edges KCR08
CTK FC	GK29512K-80360082	80360082	13507	CTK FC 29.5x12.0x1.5 C-14 a-35 B-20 4-cutting edges KCR08
CTK FC	GK495120K-80360089	80360089	13520	CTK FC 49.5x12.0x1.5 C-26 a-35 B-20 4-cutting edges KCR08
CTK FC.. 3H				
 				
CTK FC	GK50012K-80358958	80358958	13327	CTK FC 50.0x12.0x1.7 3 holes C-37 a-35 B-20 4-cutting edges KCR08

Type	GRASCHE USA Part #	Article	Profile Blank Description	
CTK MK..BCG				
				
CTK MK..BCG	GK30055K-11998684	11998684	13397	CTK MK 30.0x5.5x1.1 Back Cross Groove KCR08
CTK GR..				
				
CTK GR	GK180180H-80330658	80330658	13293	CTK GR 18.0x18.0x1.95 SPUR HC20

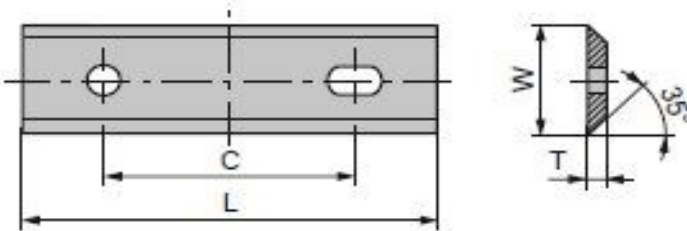
Type	GRASCHE USA Part #	Article		Profile Blank Description
CTK FC.. CB				
				  
CTK FC.. CB	GK15015M-80239392	80239392	14029	CTK FC 15.0x15.0x2.0 a-35 4-cutting edges CB MG18
CTK SC.. 3CUT				
				  
CTK SC	GK220M-80239466	80239466	13271	CTK SC 22.0x 2.0 3-cutting edges a-30 Triangle MG18

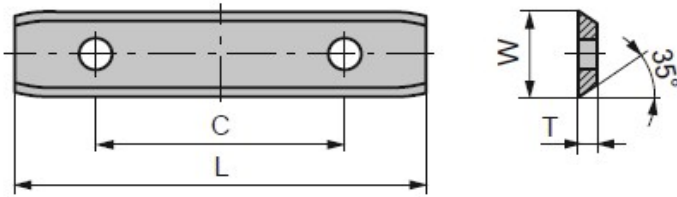
Type	GRASCHE USA Part #	Article	Profile Blank Description	
CTK SK..				
  				
CTK SK	GK29512K-80360071	80360071	13430	CTK SK 29.5x12.0x1.5 LH15° a-35 2-cutting edges KCR08
CTK SK	GK29515K-80360070	80360070	13431	CTK SK 29.5x12.0x1.5 RH15° a-35 2-cutting edges KCR08
CTK SK	GK49512K-80360073	80360073	13432	CTK SK 49.5x12.0x1.5 LH15° a-35 2-cutting edges KCR08
CTK SK	GK49512K-80360072	80360072	13433	CTK SK 49.5x12.0x1.5 RH15° a-35 2-cutting edges KCR08
CTK ST				
  				
CTK ST	GK75012K-80360013	80360013	12001	CTK ST 7.5x12.0x1.5 a-35 2-cutting edges KCR08
CTK ST	GK96012K-80360014	80360014	12015	CTK ST 9.6x12.0x1.5 a-35 2-cutting edges KCR08
CTK ST	GK10512K-80360015	80360015	13155	CTK ST 10.5x12.0x1.5 a-35 2-cutting edges KCR08
CTK ST	GK15012K-80360018	80360018	12003	CTK ST 15.0x12.0x1.5 a-35 2-cutting edges KCR08
EL CTK ST	GK150120C-11791001	11791001	13972	EL CTK ST 15.0x12.0x1.5 a-35 2-cutting edges CTOPP10
CTK ST	GK20012K-80358831	80358831	115081	CTK ST 20.0x12.0x1.5 a-35 2-cutting edges KCR08
EL CTK ST	GK200120C-11791002	11791002	13977	EL CTK ST 20.0x12.0x1.5 a-35 2-cutting edges CTOPP10
CTK ST	GK20012S-80330673	80330673	41587	CTK ST 20.0x12.0x1.5 a-35 2-cutting edges SMG02
CTK ST	GK24712K-80360024	80360024	12011	CTK ST 25x12.0x1.5 a-35 2-cutting edges KCR08

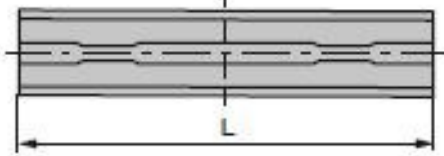
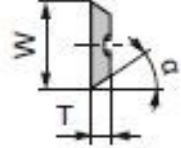
Type	GRASCHE USA Part #	Article	Profile Blank Description	
CTK ST				
				 
CTK ST	GK800130K-80360069	80360069	10631	CTK ST 80.0x13.0x2.2 c-60 a-35 2-cutting edges KCR08
CTK ST	GK100130K-80360084	80360084	106832	CTK ST 100.0x13.0x2.2 c-60 a-35 2-cutting edges KCR08
CTK ST	GK120130K-80360085	80360085	106833	CTK ST 120.0x13.0x2.2 c-60 a-35 2-cutting edges KCR08
CTK ST.. BO				
				 
CTK ST BO	GK30012H-80357890	80357890	112875	CTK ST BO 30x12x1.5 Blended corners A=35 HC05
CTK ST BO	GK40012H-82018841	82018841		CTK ST BO 40x12x1.5 Blended corners A=35 HC05
CTK ST BO	GK50012H-80357892	80357892		CTK ST BO 50x12x1.5 Blended corners A=35 HC05

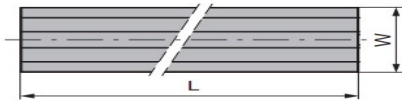
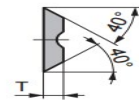
Type	GRASCHE USA Part #	Article	Profile Blank Description	
EL CTK PK..				
				  
EL CTK PK	GK820550C-11801133	11801133	13020	EL CTK PK 82.0x 5.5x1.1 2-cutting edges CTOPP10
 PLANER BLADES TERMINUS				
CTK TM..				
				  
CTK TM	GT8014M-11852103	11852103	100804	80x14.1x2.56 Terminus MG18
CTK TM	GT15014M-11852113	11852113	100809	150x14.1x2.56 Terminus MG18
CTK TM	GT10014M-11852107	11852107	100805	100x14.1x2.56 Terminus MG18
CTK TM	GT13014M-11852112	11852112	55496	130x14.1x2.56 Terminus MG18
CTK TM	GT16014M-11852115	11852115	10081	160x14.1x2.56 Terminus MG18
CTK TM	GT18014M-11852118	11852118	100813	180x14.1x2.56 Terminus MG18
CTK TM	GT23014M-118521266	11852126	54752	230x14.1x2.56 Terminus MG18
CTK TM	GT65014M-11852401	11852401	55501	650x14.1x2.56 Terminus MG18

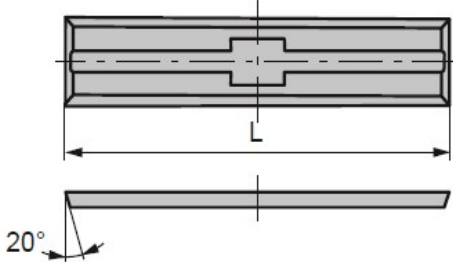
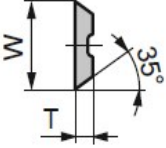
Type	GRASCHE USA Part #	Article		Profile Blank Description
<p>CTK MK..BCG</p>   				
CTK MK BCG	GK50550H-80331409	80331409	13361	CTK MK.. BCG 50.0 x 5.5 xx 1.1 Back Cross Groove HC05